

BORE FINISHING



Single-Pass Superabrasive Finishing Systems



Engis® – Your Partner in Superior Bore Finishing Technology

For more than 35 years Engis Corporation has been at the leading edge in single-pass bore finishing technology. Known throughout the world for our application knowledge, full system solutions and superior after-sale service, Engis is committed to:

State-of-the-Art Equipment and Tooling

- Engis has the ability to provide end-to-end system solutions with full automation packages and robotic parts handling.
- We offer standard machine designs as well as custom engineered platforms.
- Our engineering team has proven solutions for the finishing of both through and blind bores.
- We design and manufacture flexture tooling for exceptional cylindricity and roundness.
- Engis is a leader in seating tool technology.
- We also offer deburring stations and associated tooling.

Cutting Edge Process Development

- Engis has dedicated engineering teams for designing systems, tools and fixtures.
- Our process development laboratory has full manufacturing modeling capabilities.
- We can produce pilot runs of components utilizing single-pass technology for proof-of-concept.
- Above all, we focus on your needs; geometry, surface finish, cycle times and overall costs.



Unified Global Presence

- Engis has sales and service offices located in North America, East Asia and Europe, supplemented by our global distribution network.
- Our bore finishing systems are operating throughout the world.
- We have successful applications in most every market including automotive, hydraulic, compressor, gear and firearm manufacturers.
- High quality and high ethical standards are guiding principles throughout the Engis Group of Companies.



Engis is committed to providing superior products and services. We faithfully comply with all of the requirements of our ISO 9001:2008 Quality Management System and renew this pledge through continual improvement of our products and motivation of our global staff.



Single-Pass Bore Finishing

MACHINE & CONTROLS ▪ TOOLING & FIXTURES ▪ AUTOMATION & PROCESS DEVELOPMENT

Combining our application knowledge, process development laboratory and full system solutions, Engis is in a unique position to optimize your part quality, decrease cycle times and reduce costs.

We have complete control over the process and results because we design and manufacture the machines, fixturing and tools in-house.

With our global presence, we have equipment installed even in very remote and isolated manufacturing locations. Our commitment to the process, quality and after-sale service has ensured years of trouble-free operation under the most demanding manufacturing environments.

Benefits of the Engis® Single-Pass System:

- Reduced labor costs through automated systems
- Lower cost per bore through long tool life
- Predictable, consistent results (SPC values >2.0 Cpk)
- Improved bore quality
- Eliminates rejects/rework
- Less frequent part inspection
- Shorter cycle times
- Higher production rates
- Backed by the experience of the Engis team



From machine and tool design to automated support systems, Engis provides end-to-end single-pass bore finishing expertise.

Hydraulic Valve Body Case Study

INDUSTRY: Construction Machinery Manufacturing

MATERIAL: Cast Iron

- PROBLEM:**
- Inconsistent bore geometry
 - High down-time
 - High perishable tool cost

ENGIS SOLUTION:

- Improved quality: Cpk >1.67
- Improved bore roundness to under a half of a micron
- Ability to improve bore straightness
- Reduced perishable tool cost to under \$0.01 per part



BORE QUALITY	REQUIRED	ACHIEVED
Size:	±0.001 mm	0.001 mm
Cylindricity:	0.003 mm	0.002 mm
Roundness:	0.003 mm	0.0005 mm
Surface Finish:	0.2Ra	0.12Ra

Single-Pass Bore Finishing vs. Conventional Honing

Conventional hole finishing/bore honing utilizes a tool with cutting surfaces that expand and contract as the tool reciprocates in the bore through the cycle. Unfortunately, simultaneous radial and axial movement makes controlling bore size (ID) and geometry (cylindricity) more difficult.

Conversely, the Engis single-pass bore finishing process uses fixed-size bore finishing tools electroplated with diamond abrasive particles. These tools pass through the bore only once, removing a specific amount of material.

Using a series of progressively larger bore finishing tools (coated with progressively finer superabrasive particles) enables precise and repeatable control.

Comparison of Conventional and Single-Pass

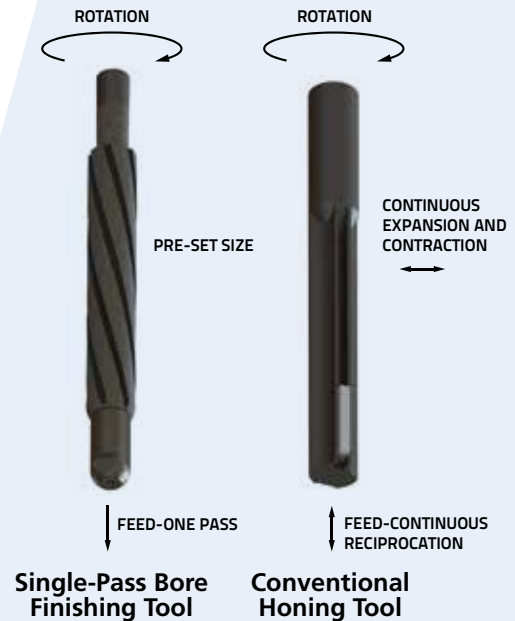

Shortest Cycle Times in the Industry

Because Engis single-pass technology spreads the workload over a range of tools on an indexing table, cycle times can be dramatically reduced versus conventional stroke honing or other finish bore operations.

The Engis system optimizes a combination of software, in-process sensors and sophisticated engineering to achieve the most efficient cycle times. Our application engineers have decades of experience working in-house in our laboratories, as well as in the field, to improve customers' part quality and productivity.

Engis® Single-Pass Process Spreads the Workload over a Series of High-Precision Electroplated Diamond Tools

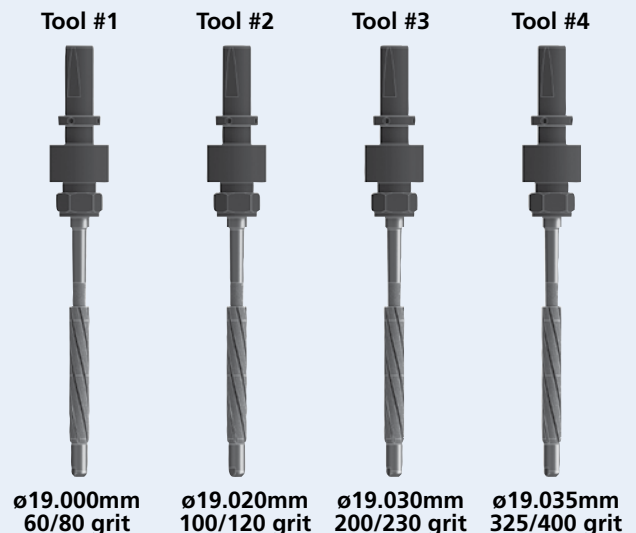

Superior Quality with Engis® Single-Pass

AUTOMOTIVE ■ HYDRAULIC ■ COMPRESSOR ■ FIREARM COMPONENTS

With Engis single-pass bore finishing technology, extremely tight tolerances (such as 0.0005mm) on bore geometry can be maintained under production conditions. The improved bore geometries translate directly into productivity gains and major reductions in costs. And since the Engis system is also user-friendly, the need for skilled operators in the honing department can be reduced dramatically, or even completely eliminated.

Engis also has solutions for blind bores, components with windows and roll-over burrs, as well as long stroke applications such as gun barrels.

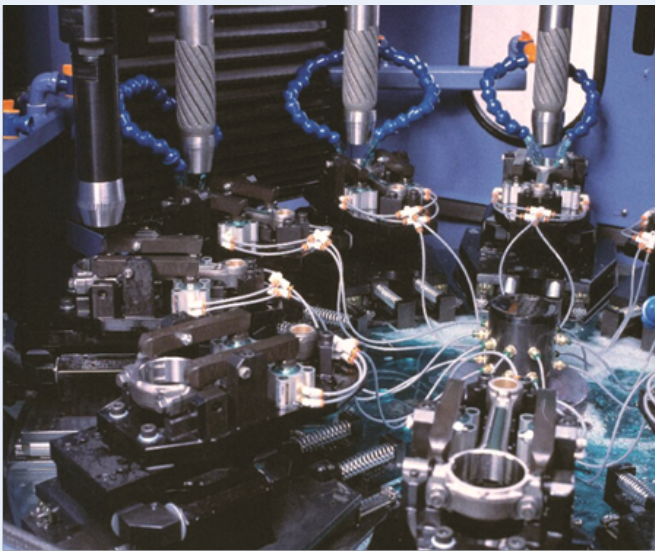

Engis bore finishing technology has helped improve the quality of automotive connecting rod bores.

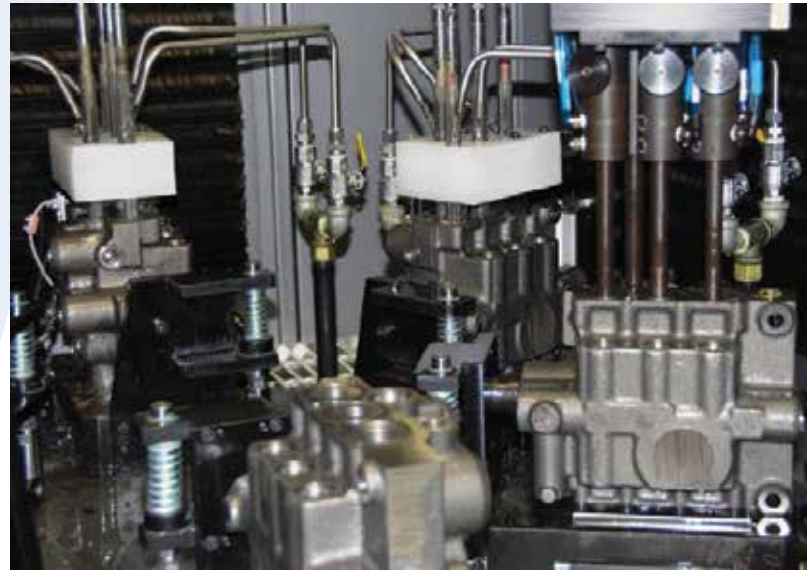

Simultaneous precision finishing and gauging of four bores in a hydraulic valve body.

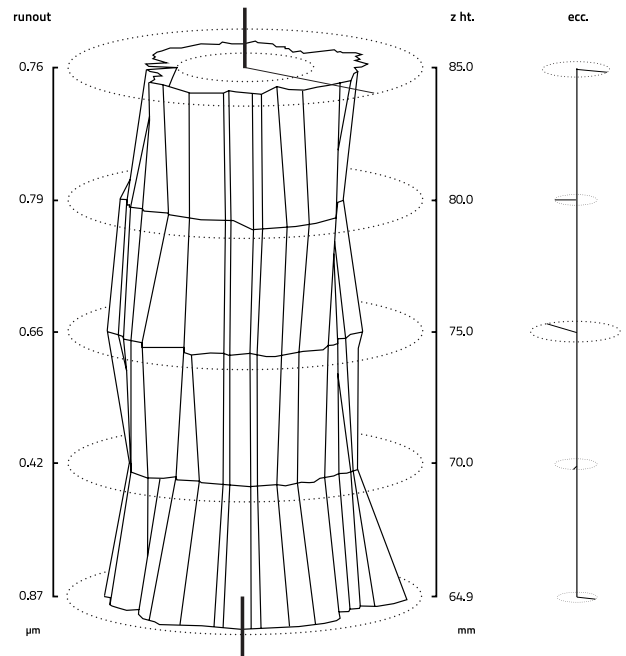

To accurately measure cylindricity of customer components, Engis utilizes technology from Taylor Hobson Ltd.

Single-Pass is the Manufacturers' Choice in Industry

- Hydraulic
- Pneumatic
- Ceramic
- Compressor
- Gear
- Aerospace
- Precision Machining
- Powdered Metal
- Firearms
- Wire Die
- Automotive
- Connecting rods
- Rocker arms
- Tappet bores
- Cam & crank bores
- Fuel systems
- Steering systems
- Brake systems
- Turbo chargers
- Transmission components

Standard Machines Configured to Your Specification and Your Process



Micro Precision Machine (MPM)

The MPM series of machines is designed to handle small parts with bore sizes ranging from 1.4mm to 10mm in diameter.

Features:

- Independent spindle motors with variable speed and accurate torque monitoring capability
- Servo fed column design
- 254mm (10") stroke
- Schneider Electric user-friendly controls
- Compact footprint
- Electro-mechanical, cam-style precision indexer
- Ability to run remotely with an iPad or similar device

Small Production Machine (SPM)

The SPM series of machines is designed to meet the needs of job shops for small to medium size parts. Available in 4, 6, 8 and 10 spindle models, these systems are primarily for bores up to 51mm (2") diameter.

Features:

- Servo fed column design
- 457mm (18") stroke
- Mitsubishi full CNC controls capable of supporting optional advanced features
- Class 7 duplex spindle bearings
- 1-1/16" diameter ASA spindles
- Pre-lubricated for life linear slides and ball screw
- Pneumatic counterbalance on head
- Electro-mechanical, cam-style precision indexer

Optional Configurations Include:

- Extended stroke lengths
- Higher horsepower motors (UM)
- Siemens, Allen-Bradley or Schneider electric controls packages



Large Production Machine (LPM)

The LPM series of machines is designed to meet the needs of job shops for medium to large size parts. Available in 4, 6 and 8 spindle models, these systems are primarily for bores up to 152mm (6") diameter.

Features:

- Servo fed column design
- 635mm (25") stroke
- Mitsubishi full CNC controls capable of supporting optional advanced features
- Class 7 duplex spindle bearings
- 1-3/8" diameter ASA spindles
- Pre-lubricated for life linear slides and ball screw
- Pneumatic counterbalance on head
- Electro-mechanical, cam-style precision indexer



3-Axis Flexible Performance Machine (FPM-3X)

Manufacturers of large hydraulic valve bodies face a challenge aligning and finishing bores once the bodies have been stacked. The FPM-3X enables bore finishing after stacking of the valves, improving overall cylindricity and roundness.

Features:

- Linear bearing vertical slide with ball screw feed and 750mm (30") stroke
- BT-40 style spindle with hydraulic drawbar arrangement
- X-Y axis linear bearing horizontal slide base
- 8 – 13 pocket automatic tool changer
- Wireless probe system for precise bore location



All Engis® bore finishing machines are designed and assembled in our state-of-the-art facility in Wheeling, IL U.S.A.

Customized Machine Designs

Not every bore finishing application fits neatly onto a standard machine platform. In those cases, our engineers will design a unique system around the application which will optimize the part geometry at minimal cycle times and costs.

With over thirty years of application and manufacturing experience, you can have confidence that a custom solution from Engis® will put you ahead of your competition and on the cutting edge of your industry.

We have a number of custom designed bore finishing solutions for the hydraulic, automotive, compressor and firearm markets in full production throughout the world.

Examples from the Specialty Series:

- In-line transfer system
- Concentricity establishing model
- Automated pressing, polishing and bore finishing model
- Multi-column system for large parts including bore finishing, gauging, brushing, face deburring and marking
- Machines with special multi-spindle arrangements capable of simultaneously finishing multiple bores in a part



Advanced Gauging Systems

- Computer aided gauging solutions with multiple graphical output formats
- Static and dynamic air gauging for precision bore geometry analysis
- Real-time data insures improved process control
- Complete statistical process control (SPC) and customized data reporting
- Report data to any or all of the following: machine, cell or customer's network
- Industrial tool size reporting via custom routines

Superior Machine Design & Features Boost Productivity and Safety

One of the most critical features in any bore finishing system is the workholding fixture design. At Engis®, each application is carefully reviewed to determine the best approach to fixture the part so that the bore geometry objectives can be achieved. Other key factors such as simplicity, versatility and quick changeover are also taken into consideration so that the entire process can be accelerated without compromising part quality.

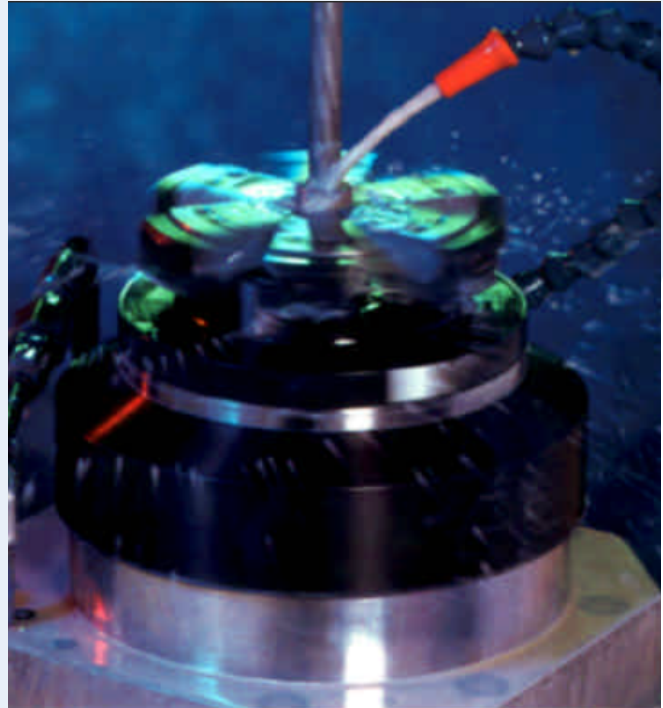

Whether it's a process that requires rotating fixtures, blind and semi-blind bore finishing, bore-to-datum concentricity applications – even OD finishing – Engis designs solutions tailored to each customer's application.



Automatic probing to find bore location and create machine offsets.

Optional Features & Enhancements

- Spring-loaded "Crash Sensors", interlocked with machine controls protect machine and tooling from potential accidents
- Shadow gauges detect misloaded components – interlocked with machine controller
- Full-perimeter guarding with light curtain for added operator safety
- "Walk Away" switch enables increased production potential
- Wide variety of automation & gauging packages
- Torque-based feed compensation

Custom Automation Systems

Engineered to Optimize Productivity

Engis® provides complete, customized automation packages, including both in-bound and out-bound product flow.

From pick-and-place units and robotics, to in-process gauging and sensor systems, to conveyor systems linking automated machining cells, Engis is capable of helping you design, engineer, test and deploy the right solution.



Through integrated controls and automation systems, Engis bore finishing systems bring new cost-saving efficiencies to operations the world over.

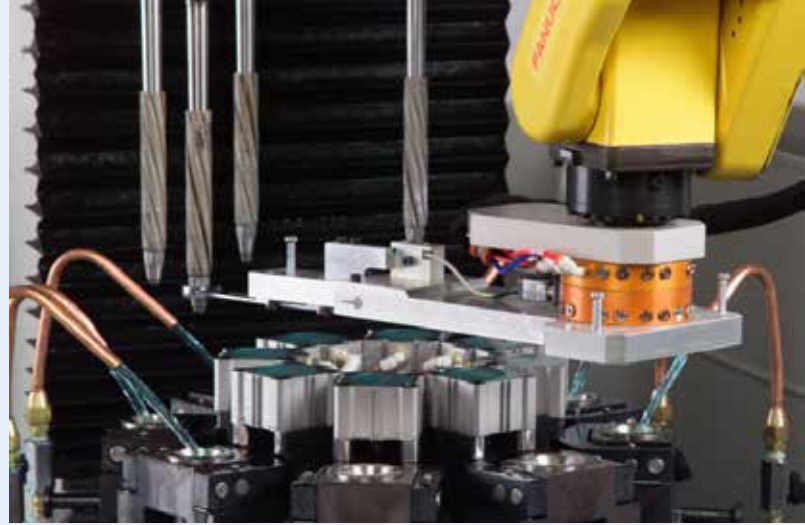

Automatic size compensation packages (through spindle or robotically actuated).

Among the specific automation systems and capabilities offered are:

- Pick-and-place units
- Robotics
- Bowl feeders
- Conveyors
- Discharge chutes
- In-process sensor monitoring
- In-process tool adjustment systems

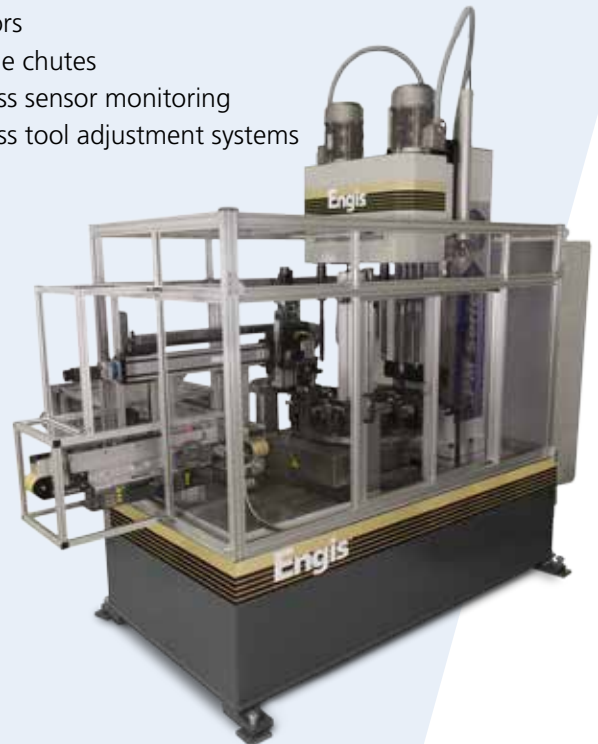

Engis® Diamond Plated Bore Finishing Tools

THE KEY TO HIGH-PRECISION FINISHING

Engis is a world recognized authority in both the manufacturing and application of precision bore finishing tools.

Our engineers have successfully resolved a myriad of difficult application challenges maintaining sub-micron bore tolerances without sacrificing cost or cycle times.

Since Engis bore finishing tools are electroplated, not bonded with a metal or vitrified matrix, the superior diamond particle exposure provides for cooler cutting action and better size control versus more conventional honing tools.

Some options available are:

- Blind bore tools
- Flexure and U-joint tools
- Coolant-through designs
- Self-adjusting tools
- Specialized tools for bore-to-datum concentricity
- OD finishing tools
- Seating tools



All Engis tool manufacturing strictly adheres to our ISO 9001-2008 quality certification system.

Leaders in Superabrasive Finishing Systems



Engis Asia Pacific Pte. Ltd.

SINGAPORE
Tel: 65-6745-1923
Fax: 65-6745-2907
Email: sales@engis.com.sg



Engis Corporation

Wheeling, IL U.S.A.
Tel: (847) 808-9400
Fax: (847) 808-9430
Email: info@engis.com



Engis-Japan Co., Ltd.

Yokohama, JAPAN
Tel: 81-45-474-0666
Fax: 81-45-474-0677
Email: email@engis.co.jp



Engis Korea Co., Ltd.

Gyeong Gi-Do., KOREA
Tel: 82-31-354-1426
Fax: 82-31-354-1430
Email: engis@engis.co.kr



Engis (H.K.) Ltd./China

Kwai Chung, HONG KONG
Tel: 852-26100903
Fax: 852-24234509
Email: sales@engis.com.hk

THE ENGIS® GROUP OF COMPANIES



Engis of Canada Ltd.

Burlington, Ontario, CANADA
Tel: (905) 632-3016
Fax: (905) 632-4250
Email: engiscanada@engis.com



Helical Lap & Mfg. Company

Mt. Clemens, MI U.S.A.
Tel: (586) 307-8322
Fax: (586) 307-8325
Email: info@helicallap.com



Engis (UK) Ltd.

Oxfordshire, ENGLAND
Tel: 44-1491-411117
Fax: 44-1491-412252
Email: sales@engis.uk.com

Hyprez® Lapping/Polishing Systems

Beginning-to-end flat finishing systems – machines, plates, pads, diamond powders, slurries, lubricants and other accessories – plus customized equipment, specialized formulas, testing labs and technical support for process and technology development.

DiaMold® Toolroom Products

Comprehensive line of diamond polishing compounds, abrasive stones, sticks, bobs, brushes and files – plus powered hand finishing systems for every toolroom application.

Engis Single-Pass Bore Finishing Systems

Single-pass bore finishing systems – standard models and custom machines – plus diamond and CBN plated finishing tools, parts holders/fixtures and integrated automation system.

Electrogrip® Grinding Systems

Advanced superabrasive grinding, cutting and dressing systems utilizing diamond and CBN materials. Specializing in the aerospace, medical, ceramic, automotive and composite industries.



Leaders in Superabrasive Finishing Systems

ENGIS CORPORATION

105 W. Hintz Road • Wheeling, IL 60090-6038
Phone: 847.808.9400 • Toll Free: 1.800.99.ENGIS
Fax: 847.808.9430 • E-mail: info@engis.com
Website: www.engis.com



Engis is a registered trademark of Engis Corporation U.S.A. and other countries.
All products designated with ® or TM are registered Trademarks or Trademarks of Engis Corporation.